

**SpeedyBee
5.8GHz Goggles Receiver
User Manual**

Table of Contents

1.Specifications

2.Interactive Components

3.Quick Start Guide

- 3.1 Recevier Mounting
- 3.2 Recevier Antenna Installation
- 3.3 Power On
- 3.4 Quick Frequency Switching

4.Setup

5.Package

6.Contact Us

1. Specifications

Product Name	SpeedyBee 5.8GHz FPV Goggles Receiver
Input Voltage	5V
Working Current	450mA@5V
Frequency Channels	Support A,B,E,F,R,L frequency, 5.3GHz-5.9GHz, 48 channels
Dimension	51x34x17.8 (mm)
Weight	32g (excluding antenna)
Support FPV Goggles	
FatShark Dominator Series	V1, V2, V3, SE, HD1, HD2, HD3, HDO, HDO2.
Orqa	The current factory casing does not support Orqa goggles. We have designed 3D-printed casing that is compatible with Orqa series goggles. They support Orqa's FPV.One, FPV.One Pilot, and FPV.One Race.
HDZero	Supports HDZero FPV goggles analog conversion module.
DJI	Supports DJI V1, V2 Goggles (an adapter board needs to be purchased separately when using DJI Goggles).

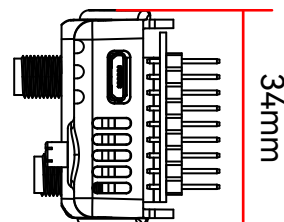
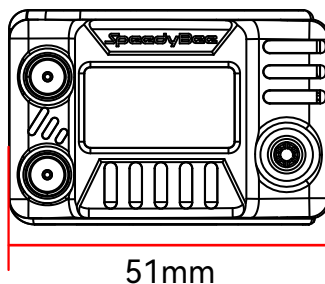
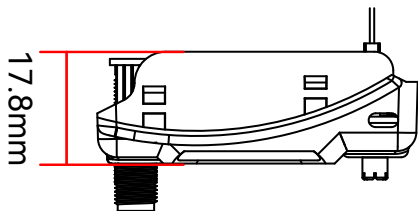

2. Interactive Components

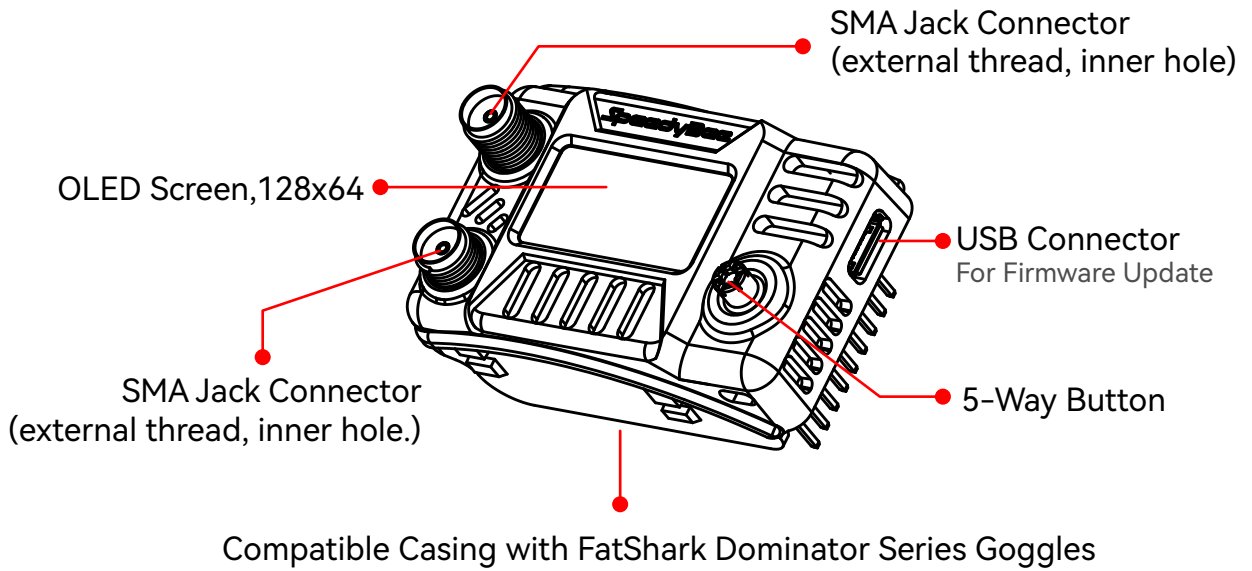

3. Quick Start Guide

3.1 Receiver Mounting

Example: FatShark HDO 2.

Instructions of how to install SpeedyBee 5.8GHz onto the goggles.

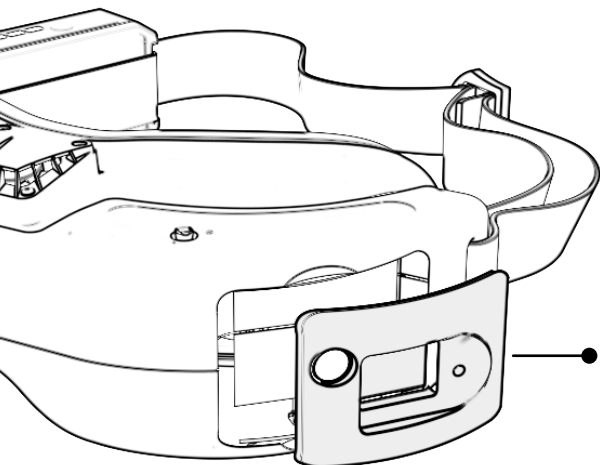

- **Step 1:** Power off the HDO 2 goggles and remove the receiver compartment panel.

Step 2: Align the receiver's pins with the female socket inside the goggles receiver compartment. Press down slowly and firmly until you feel it securely lock into place.

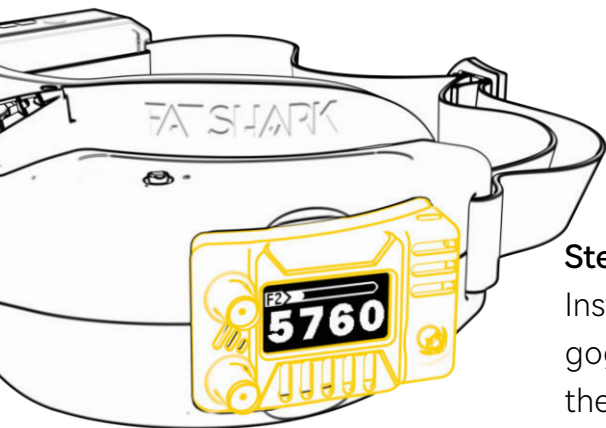
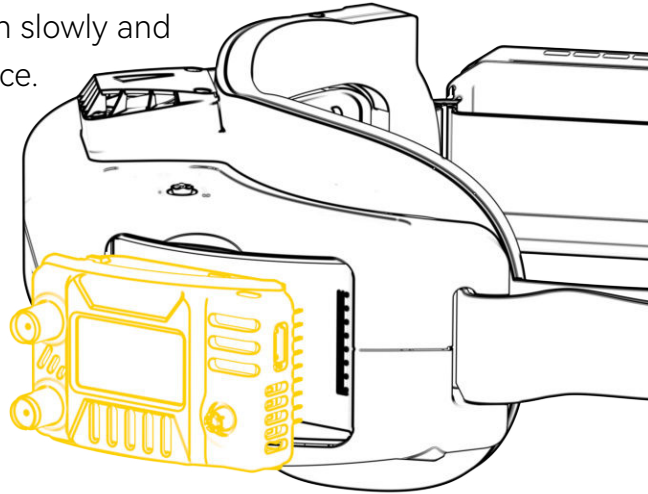
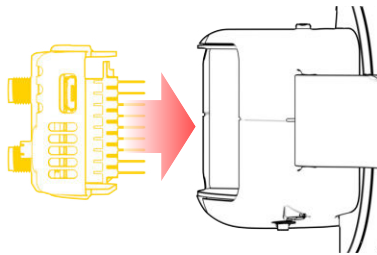

Step 3:

Installation complete! The SpeedyBee 5.8GHz goggles receiver will power on automatically when the goggles are turned on.

3.2 Receiver Antenna Installation

The receiver is equipped with two SMA Jack antenna ports, allowing for the installation of antennas with SMA Plug (internal thread + inner pin) interfaces on both ports.

To improve antenna reception, pilots commonly opt for a combination of a lollipop omnidirectional antenna and a panel directional antenna. This combination guarantees optimal coverage in terms of both the range and depth of signal reception. The lollipop antenna is typically mounted at the top, while the panel antenna is positioned below. Using the Maple Wireless receiver antenna kit as a demonstration, the following illustrates the installation process for the receiver antennas.

Accessories

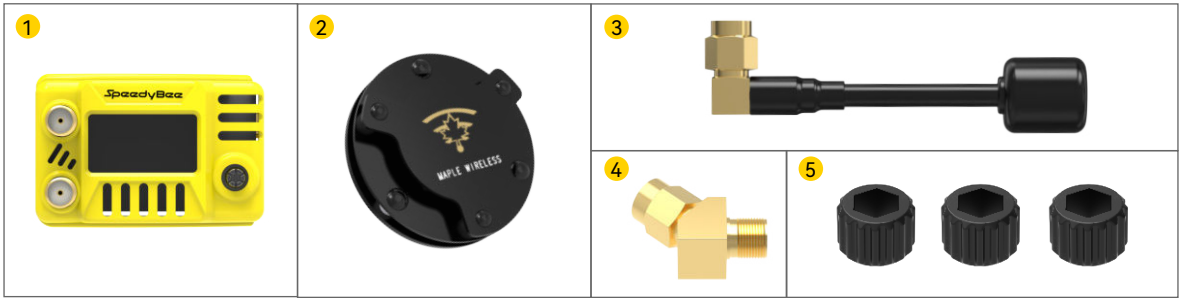

- 1 SpeedyBee 5.8GHz Goggles Receiver x 1
- 2 Maple Leaf circularly polarized sandwich antenna, Right Hand RHCP x 1
- 3 Maple Leaf Sandwich Circular Polarized Patch Antenna, Right Hand RHCP x 1
- 4 45° SMA Adapter (Used for Installing Patch Antenna) x 2
- 5 SMA Ratchet X3

Note: simply twist the SMA ratchet to secure it.

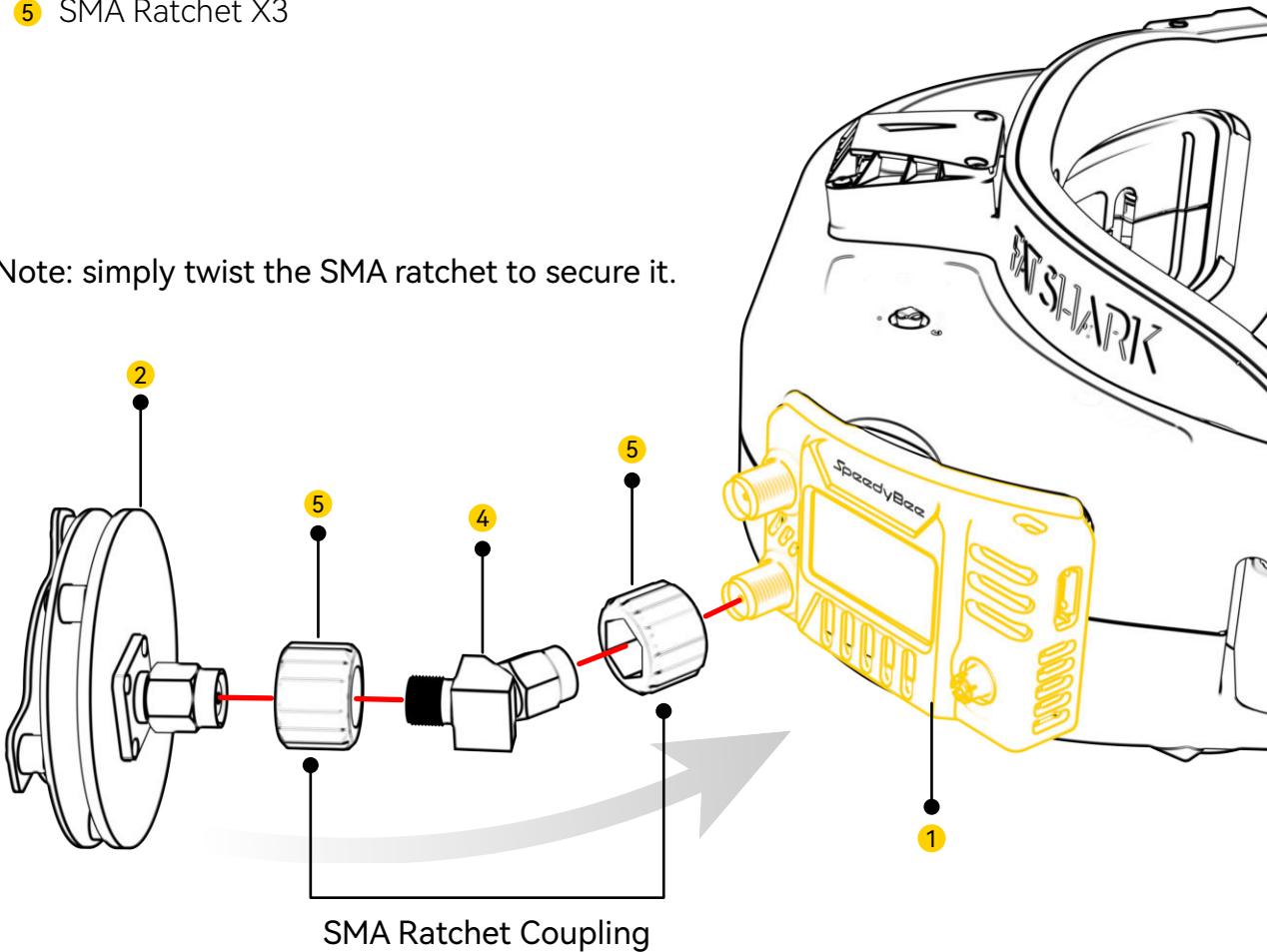

SMA Ratchet Coupling

*Note: simply twist the SMA ratchet to secure it.

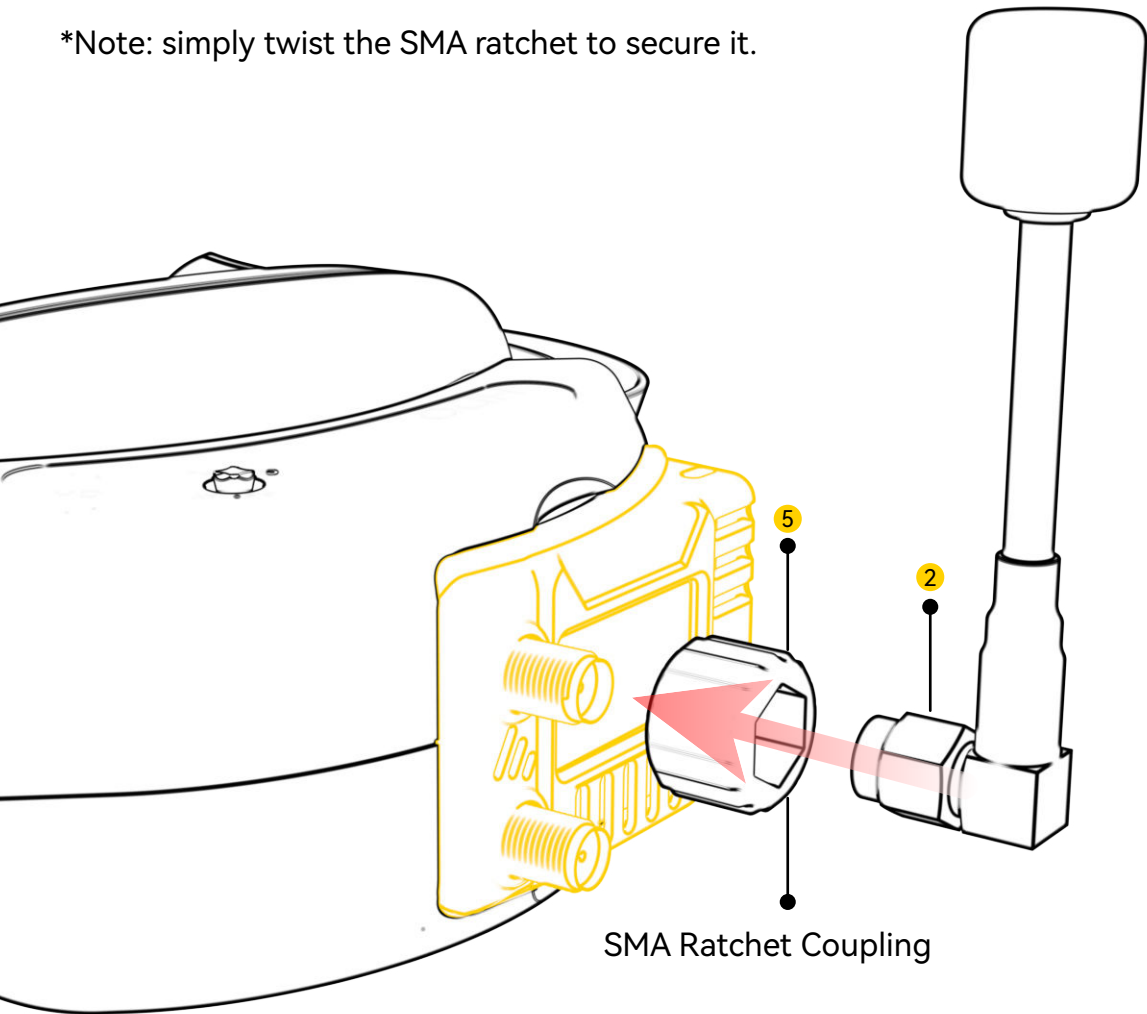

SMA Ratchet Coupling

For a more visual demonstration of the steps outlined above, you can scan the QR code using any QR code scanning application. It provides a more comprehensive illustration of the installation.



3.3 Power On

current frequency band
and frequency point

signal strength

Once the installation of the receiver and antenna is completed, powering on the goggles will activate the receiver. The receiver will then display the current frequency information.



current frequency

3.4 Quick Frequency Switching

For convenient frequency point switching, we have designed a cross menu. The horizontal menu represents frequency bands, and the vertical menu represents frequency points. Use the 5-way button to navigate and select the desired frequency band and point. Pressing the 5-way button will set the selected frequency point as the current frequency.

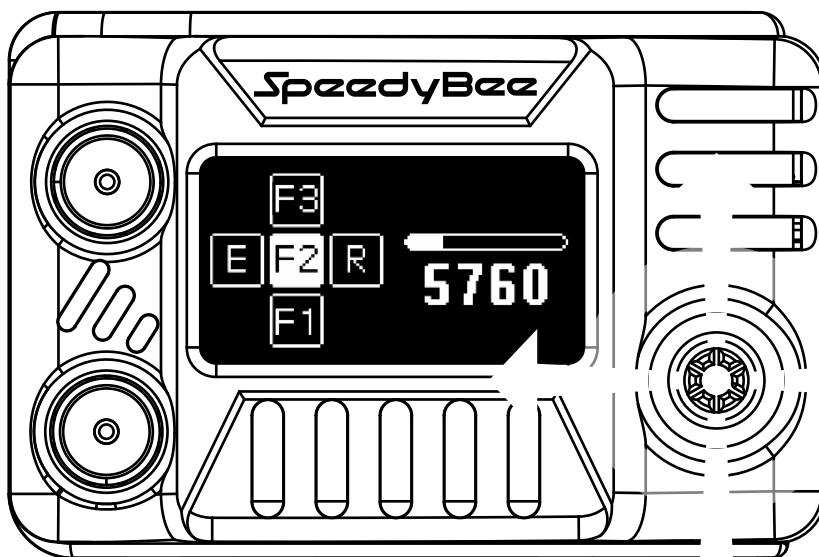

4 . Setup

Press the 5-way button on the home screen to enter the settings menu interface.

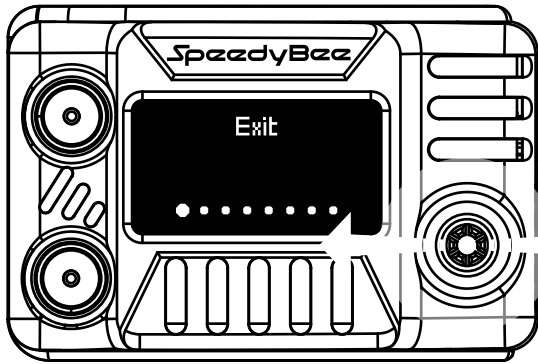

Left/right for switching

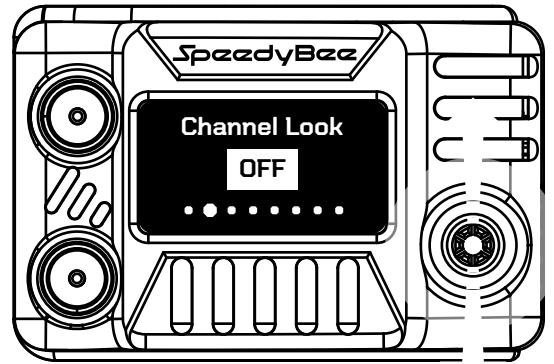

up/down for selecting

The 5-way button operation

Menu item switching: Left/right on the 5-way button.

Modifying setting values: Up/down on the 5-way button to modify setting values and then press the button to apply

Returning to previous menu: Left on the 5-way button.

Menu item: Exit

Description:

Pressing the 5-way button in this menu allows you to exit the settings menu.

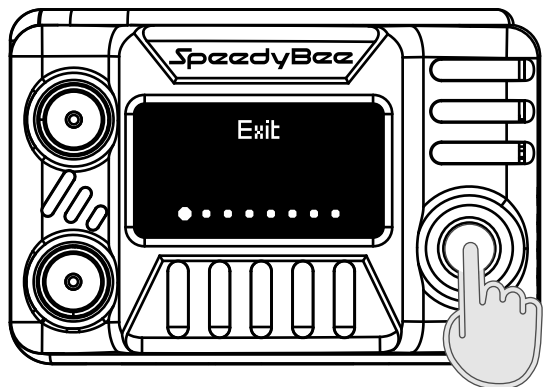

Menu item: Channel Lock

Description: Frequency lock is a highly useful feature that prevents accidental modifications to the frequency point while navigating the quick frequency switching interface. When this feature is enabled (set to ON), the receiver locks the current frequency point. This means that you cannot modify the frequency point within the quick frequency switching interface, thus avoiding unnecessary changes and ensuring flight safety.



When "Channel Lock" is OFF, it is the home screen interface.



When "Channel Lock" is ON, the home screen interface will display a lock icon.

Menu item: Band

Description: Frequency scanning is a utility menu item that allows you to quickly view valid frequency points within six different bands. You can navigate through the frequency points using up and down on the 5-way button, and then press the 5-way button to set it as the current frequency point. This feature is highly practical and helps you quickly identify available frequency points, enhancing flight stability and signal quality.

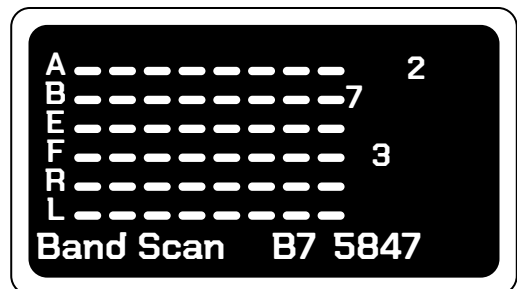
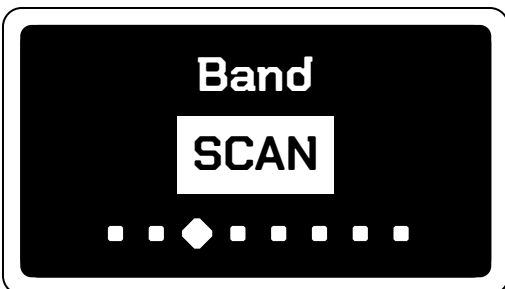

Menu item: Finder

Description: The Find drone feature is a highly practical function that displays the signal strength of the upper and lower antennas and emits beeping sounds at varying speeds based on the signal strength. The purpose of this feature is to assist you in locating your drone faster in the event of an uncontrollable descent. By gradually narrowing down the search area based on signal strength, you can locate your drone more efficiently. When you enable the Find drone function, you will hear beeping sounds whose speed and frequency reflect the current signal strength. This allows you to easily assess the relative position of the drone to your location and progressively reduce the search area to locate the lost drone.

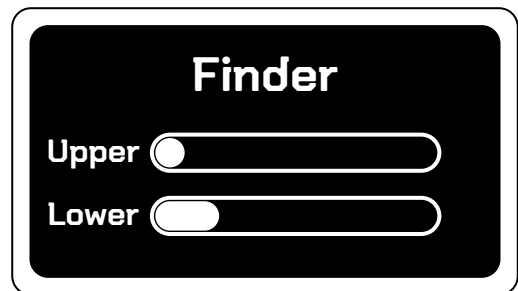
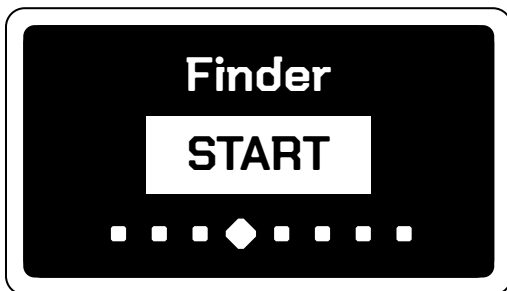

Menu item: RSSI OSD

Description: On the goggles, we have implemented a real-time display of the FPV signal strength feature called RSSI OSD (On-Screen Display). When enabled, you will see two signal bars at the top of the screen, representing the signal strength of the two antennas. This feature provides you with a visual indication of the current signal quality during your flight, ensuring safe operation. The feature is enabled by default, but you have the option to disable it or set the signal bars to the short signal bar mode. S.RSSI represents the short signal bars, while L.RSSI represents the long signal bars.

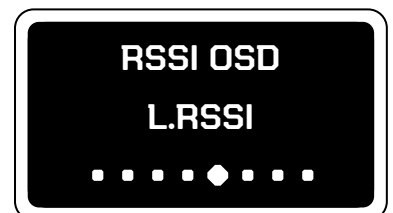
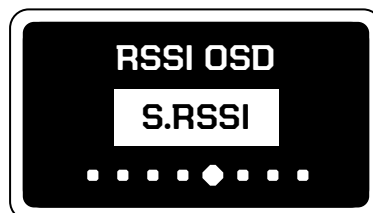
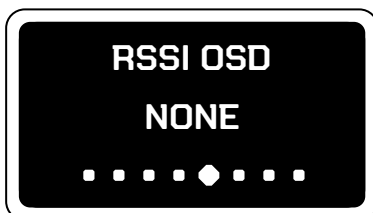

Menu item: Audio Out

Description: If your VTX or camera has an integrated microphone and audio transmission is enabled, you can transmit the audio signal received by the receiver to your FPV goggles by enabling this feature. Typically, your FPV goggles will be equipped with a 3.5mm audio jack, allowing you to plug in your headphones and hear the sound from the VTX or camera in real-time.

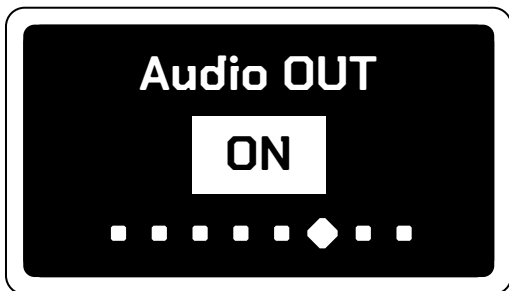

Menu item: Calibration

Description: Each receiver module has undergone calibration during the factory testing process, so in most cases, you won't need to use this feature. However, during usage, there may still be instances where the channels on the 5.8GHz goggles receiver drift, resulting in unclear images or signal loss. To address this issue, we provide the calibration feature. This feature helps you adjust the receiver's channels and frequencies to ensure optimal image quality and signal stability.

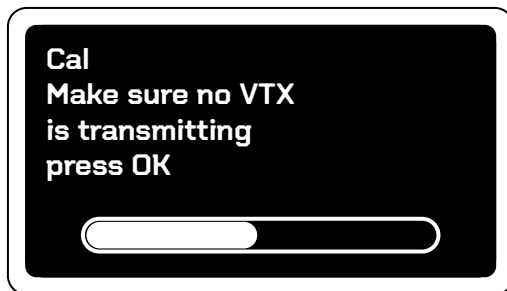

Calibration Steps:

Step 1:

- 1.Remove the two antennas from the receiver module and ensure that there are no active VTX (video transmitter) devices in the vicinity.
- 2.Select A1 (5865MHz) as the current frequency point to avoid interference from Wi-Fi signals. Then, enter the calibration menu and press the 5-way button to start the calibration.
- 3.Once the calibration is complete, the screen will display the calibration status and inform you whether the calibration was successful.

Step 2:

- 1.Power on the VTX transmitter and set it to 25mW, with the video transmission frequency set to A1 (5865MHz).
- 2.Keep a distance of approximately 1 meter between the VTX and the receiver. Press the 5-way button on the calibration interface to start the calibration.
- 3.Once the calibration is complete, the screen will display the calibration status and inform you whether the calibration was successful.

If calibration fails, it may be due to the following reasons:

- 1.In the first step of calibration, the VTX was not turned off, or there are other VTX devices in the vicinity using the same frequency channel. Make sure to turn off the VTX during calibration or perform the calibration in an area with less interference.
- 2.In the second step of calibration, the VTX was not powered on, or the receiver and VTX were not set to the same frequency channel. Ensure that the VTX is powered on and set to the same frequency channel as the receiver.

5. Package

Option 1- SpeedyBee 5.8GHz Goggles Receiver



- 1 SpeedyBee 5.8GHz Goggles Receiver X1
- 2 SMA Antenna Protective Cap X2

Option 2-SpeedyBee 5.8GHz Goggles Receiver Antenna Combo



- 1 SpeedyBee 5.8GHz Goggles Receiver X1
- 2 Maple Leaf circularly polarized sandwich antenna, Right Hand RHCP x1
- 3 MMaple Leaf Circularly polarized lollipop antenna, Right Hand RHCP X1
- 4 45 SMA Adapter (Used for Installing Patch Antenna)X2
- 5 SMA Ratchet X3
- 6 SMA Antenna Protective Cap X2

6. Contact Us

You can reach us using any of the following three methods, and we will respond to you as soon as possible.

1. Contact us through the Feedback Feature in the SpeedyBee App.
To access this feature, go to SpeedyBee App → Home Page → More Menu (at the top right of the Home Page) → Contact us.
2. Send your questions or suggestions to the email address contact@speedybee.com.
3. Connect with us on Facebook: <https://www.facebook.com/SpeedyBeeFPV>.